

PRODUCT COMPLIANCES

Product complies with:

Ruapehu LED lights comply with all applicable standards.

MANUFACTURERS EXTENDED WARRANTY

This product is guaranteed by SIMX Ltd and Ventair Pty Ltd for 5 years from the date of purchase against faulty materials or workmanship which affects its designed ability to switch and operate. During this period if the product has a defect of this nature it will be repaired or replaced free of charge by SIMX with the same item, or a similar one of higher specification.

ON CONDITION THAT:

- The buyer returns it to the seller from whom it was bought, freight paid.
- The product has been bought by the user (ie. a receipt/sales invoice is produced as proof of purchase).
- The product has not been misused or handled carelessly, installed in any way contrary to the installation instructions, or installed in any unusually exposed or harsh environmental conditions.

This guarantee excludes liability for discolouration of paint or plastic, or any user serviceable parts. It does not confer any rights other than those expressly set out above and does not cover any claims for consequential loss or damage.

Our Goods come with guarantees that cannot be excluded under either Australian, or New Zealand, Consumer Law.

You are entitled to a replacement or refund for a major failure and for compensation for any other reasonably foreseeable loss or damage. You are also entitled to have the Goods repaired or replaced if the Goods fail to be of acceptable quality and the failure does not amount to a major failure.

Specifications are subject to change without notice



Distributed in New Zealand by Simx Ltd

Ph: +64 9 259 1660 | Technical Support Ph: +64 9 259 1662
e: sales@simx.co.nz | www.simx.co.nz

Distributed in Australia by Ventair Pty Ltd

4 Capital Place, Carrum Downs, 3201 VIC, AUSTRALIA.
Technical Support: 1300 665 926
e: info@ventair.com.au | www.ventair.com.au

PUB1571 2510

INSTALLATION INSTRUCTIONS



LHT1137 ANTHRACITE 12W LED Downlight

The Simx Lighting Tarawera Downlight is a contemporary design, high quality LED luminaire. Water and dustproof, it is rated for exposed exterior locations.

TECHNICAL SPECIFICATIONS

Voltage	220-240V AC
Wattage	12W
Lumens	650 lm
LED Colour	Warm White 3000K
IP Rating	IP65
Safety	Class I
Mounting	Wall
Construction	Powder Coated Aluminium / Tempered Glass

BEFORE YOU START

Please read all the instructions prior to installation.

- The Tarawera light should be wired to its own light switch.
- Single cable installation only. Looping (IN/OUT) cabling may effect IP rating and therefore is not permitted.
- Do not connect with other lamp types on the same switch.
- An earth connection must be used for electrical safety.
For all locations, please check that the direction of the beam will not cause undue glare to neighbouring properties.

! IMPORTANT

This product is suitable for use only with a supply voltage of 220-240V AC 50Hz.

All electrical work must be carried out in accordance with local and national electrical codes as applicable. We strongly recommend that this light fitting is installed by a registered electrician.

Always switch power off prior to installation. A means of mains power isolation must be installed in the circuit for the purpose of safe access for any internal cleaning, recalibration, or maintenance.

This light fitting is not intended for use by persons (including children) with reduced physical, sensory or mental capabilities, or lack of experience and knowledge, unless they have been given supervision or instruction concerning use of the appliance by a person responsible for their safety. Young children should be supervised to ensure that they do not play with the appliance.

Any changes or modifications made or attempted to this product, without the prior written approval of the manufacturer, will void any and all stated warranties.

INSTALLATION

We strongly recommend this light fitting is installed by a registered electrician.

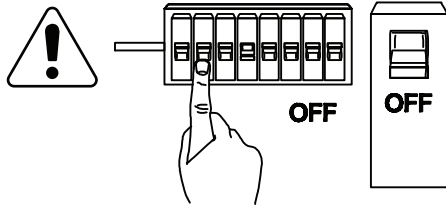

- 1** Switch off the power supply before commencing any electrical work.

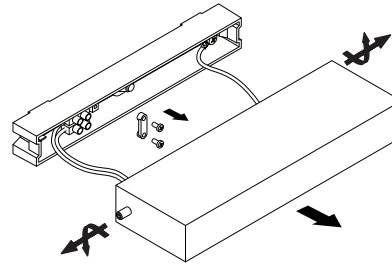

- 2** Unscrew the fixing cover screws with the allen key supplied and remove the rear mounting base.

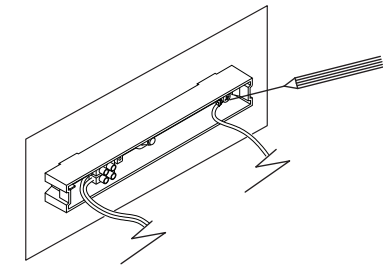

- 3** Use the rear base to mark the position of screw holes onto the mounting surface. Use a spirit level to ensure correct orientation.

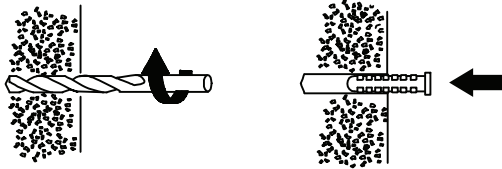

- 4** Drill the wall to depth of about 40mm and fit the wall plugs (supplied). Care should be taken to avoid drilling or screwing into concealed electrical wiring/plumbing.

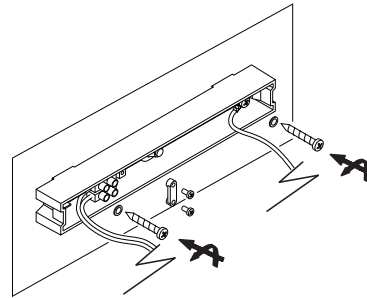

- 5** **To retain IP rating, a single TPS 3-core flat cable must be used.** Gaskets for both 1.00 and 1.5mm cables are included to select from. Push the power supply through the cable gland. Affix the rear base to the mounting surface with mounting wall screws supplied.

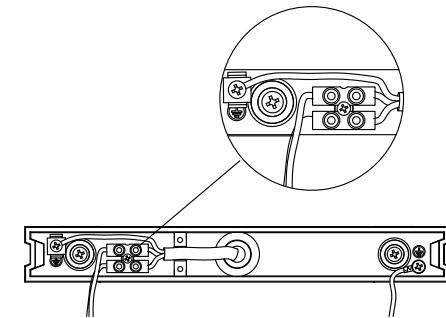

- 6** Connect the power cables to the terminal block securely using the wiring diagram in Step 7.

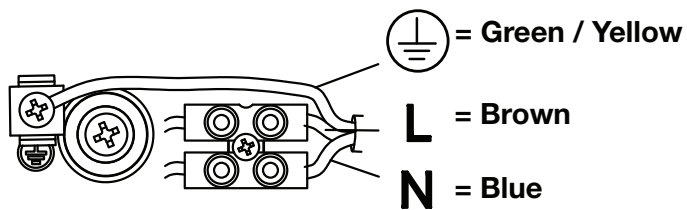

- 7** Terminate the power supply cable.

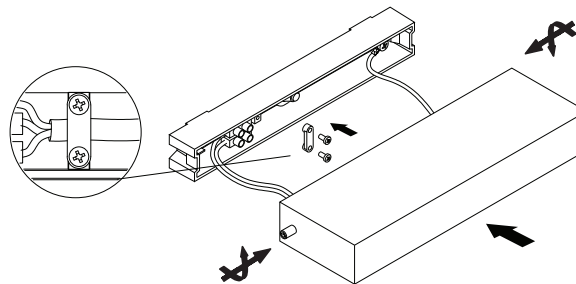

- 8** Reattach and screw securely the cover to the base. Ensure cables are not pinched when closing the unit.

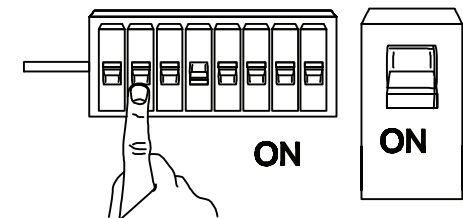

- 9** Reconnect mains power and test circuit.